

Millipore®

Preparation, Separation,
Filtration & Monitoring Products



Performance Guide

Mobius® TFF 80 System for Tangential Flow Filtration



The Life Science business of Merck
operates as MilliporeSigma in the
U.S. and Canada.

MERCK

How to Use the Guide

This Performance Guide is a reference document that provides highlights of key performance aspects of the Mobius® TFF 80 system for Tangential Flow Filtration (TFF). This guide includes information from a number of applications and case studies that were designed and/or selected to provide a diverse overview of the system performance under a range of expected processing conditions.

The results included in this guide summarize outcomes and observations obtained in studies conducted using model feed streams and experimental conditions. Therefore, all test results should be confirmed by the end user using feed stream and process conditions representative of the user's application. It is important to note that results are intended as general examples and should not be construed as product claims or specifications.

Introduction

The Mobius® TFF 80 system with Flexware® Assemblies is a fully automated system designed to enable the clinical and commercial-scale operation of TFF processes for the concentration and diafiltration of monoclonal antibodies (mAbs), vaccines, viral vectors, and therapeutic proteins. The system has the same functionalities as conventional TFF systems, and by incorporating a completely single-use flow path, it provides operational flexibility while eliminating concerns of carryover or cross contamination.

The Mobius® TFF 80 system is composed of a tank cart with pumps and a base cart holding the clamshell, which manages flow path configuration control, and monitoring. A separate holder for Pellicon® cassettes and a stand for Pellicon® capsules are available. In addition to the feed pump and transfer pump control loops, the system includes two automated flow control valves, one on the retentate line and one on the filtrate line to enable open ultrafiltration and microfiltration operations. Two flow sensors allow for retentate and filtrate flow measurement as well as flux, concentration factor, diavolumes, and membrane permeability calculations. An optional transfer line flowmeter is available. While the maximum reachable flow rate during processing may change, mainly due to the membrane area and product viscosity, the system has been designed to feed at 80 L/min with solutions from 1 to 40 cP. Two inlet configurations are available, either three inlets on each pump (transfer pump and feed pump) or five inlets on the transfer pump and none on the feed pump. Two vessel volumes can be chosen, 200 L or 500 L and both sizes are available with double jacketed carrier and temperature control. Recycle vessels come with integrated load cells, bottom-mounted mixer, and temperature sensor. Single-use pH measurement in the recycle vessel is also available as an option. Conductivity, UV, and pH instrumentation are available on the TFF filtrate line. The pH probe can be user-supplied and installed on site or pre-installed and irradiated in the Flexware® assembly. The specific system size and configuration used to generate the performance data included in this guide is specified in the methods section for each study.

Table of Contents

1	P&ID	5
2	System hold-up volume	6
3	Minimum working volume against feed flow rate	7
4	System drainability and unrecoverable volume	9
5	System pressure drop versus flow rate and viscosity	10
6	Lowest volume immersing the mixer/Mixing types according to mixer speed and recycle vessel volume at 1 cP	11
7	Temperature control performance of jacketed recycle vessel	13
8	Protein UF/DF and recovery step	16
9	Feed Bag sampling and pH measurement volume limit	18

1 P&ID

Throughout this guide, we refer to valve numbers when detailing the tests performed. The simplified P&ID below allows to easily locate each valve.

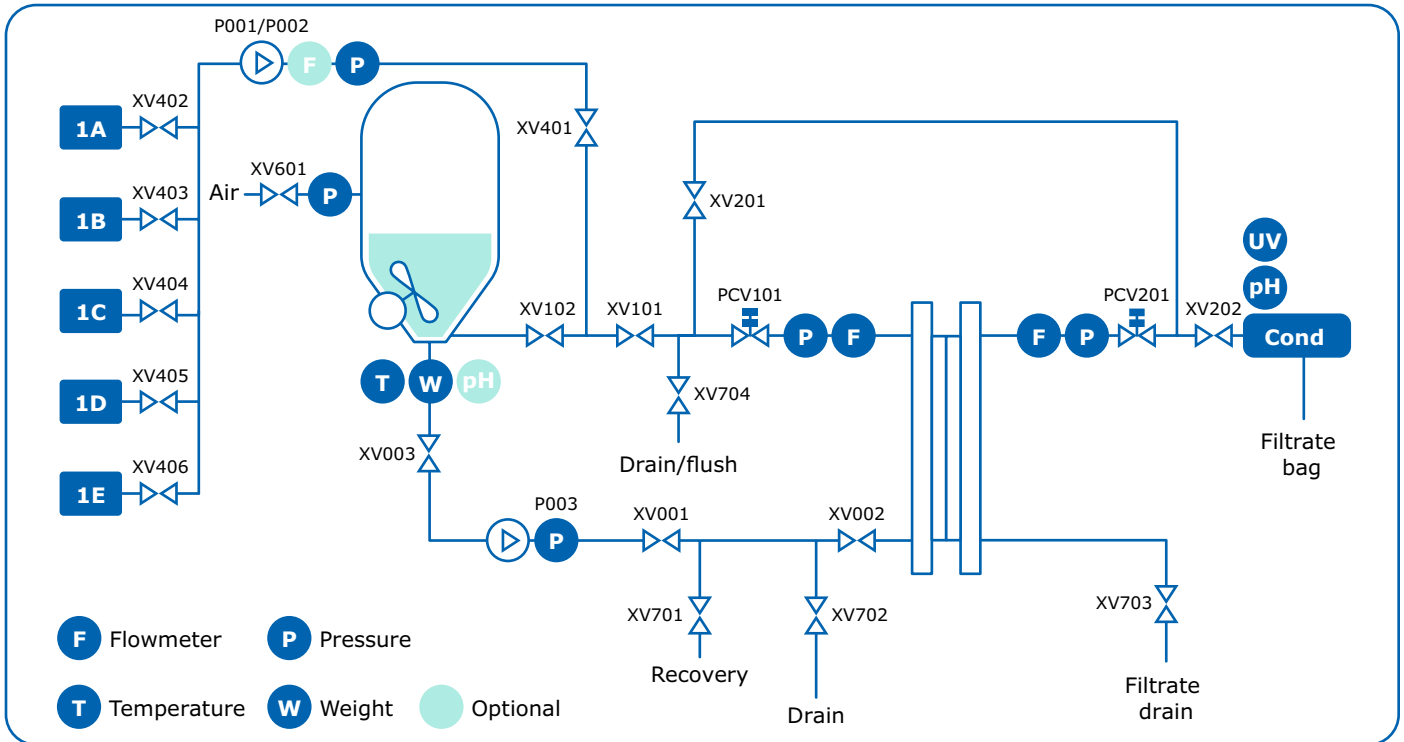

Configuration: 5 inlets on transfer line.

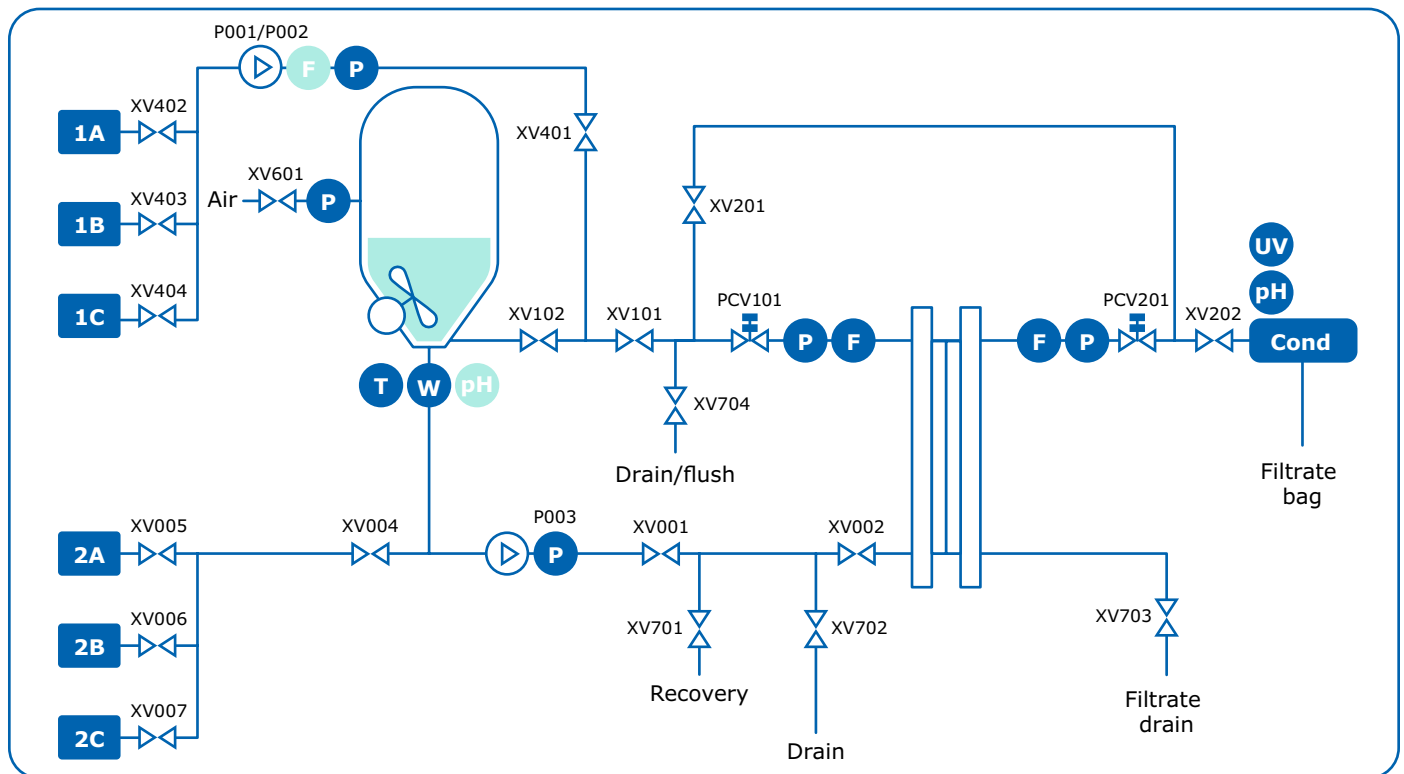

Configuration: 3 inlets on transfer line and 3 inlets on feed line.

2 System hold-up volume

Background and Objectives

The hold-up volume corresponds to the volume contained in the recirculation loop. It has to be added to the recirculation tank volume to determine the exact volume of solution contained in the system during a process. It is therefore useful to determine this volume to correctly monitor the progress of a process, if based on the volume of solution.

Materials and Methods

The following tests have been performed on all Mobius® TFF 80 system configurations of inlet manifold and tank volume. The entire Flexware® assembly is installed as supplied following the instructions provided in the user guide. The mixer motor is engaged with the impeller cup at the bottom of the bag. Two Steam-In-Place (SIP) plates (part #XX42STMPL) blocking the filtrate side are installed on the Pellicon® cassettes holder. The load cells are tared prior to adding 1 cP solution (WFI) to fill the bag up to 30 L. The amount of solution used to fill the recycle bag is confirmed thanks to a weight scale set under the ancillary bag from which it is pumped into the bag. The system is set in recirculation mode and the feed pump is started and ramped up to 80 L/min to remove any air from the flow path. Potential remaining bubbles under XV201 are removed by alternatively opening and closing XV201 and XV202. The feed line drain is connected to an empty tank placed on a weight scale and tared. The feed pump is stopped, and the solution is removed from the flow path using the feed line drain, down to 5 L in the tank. For a better precision, water is further removed using the retentate line sample port until reaching the hold-up volume (tank empty and flow path full). By subtracting the removed volume and

the SIP plate volume from the initially introduced volume, we obtain the hold-up volume.

Note: Filtration devices and surface may vary from one process to another, therefore, measured values in this study do not take this volume into account. Total retentate channels volumes of filtration cassettes must be added for exact hold-up volume determination in customer process conditions.

The Pellicon® SIP plate was used for this study in place of actual Pellicon® membrane cassettes. The Pellicon® SIP plate is a stainless steel rectangular annular ring with a thickness of 3/8". It has the external dimensions (length and width) of a Pellicon® cassette and an O-ring that allows it to be installed in a membrane holder and torqued in place. When installed, fluid or steam can flow through the holder without any significant pressure drop.

Results

The results are identical for each system configuration (200 L/500 L, inlets configuration) and are given in the table below.

Tank size (L)	Configuration		Measured hold-up volume (L)
	Inlets on feed pump	Inlets on transfer pump	
200	0	5	3.85
	3	3	3.85
500	0	5	3.85
	3	3	3.85

Table 1. Measured hold-up volume according to system configuration.

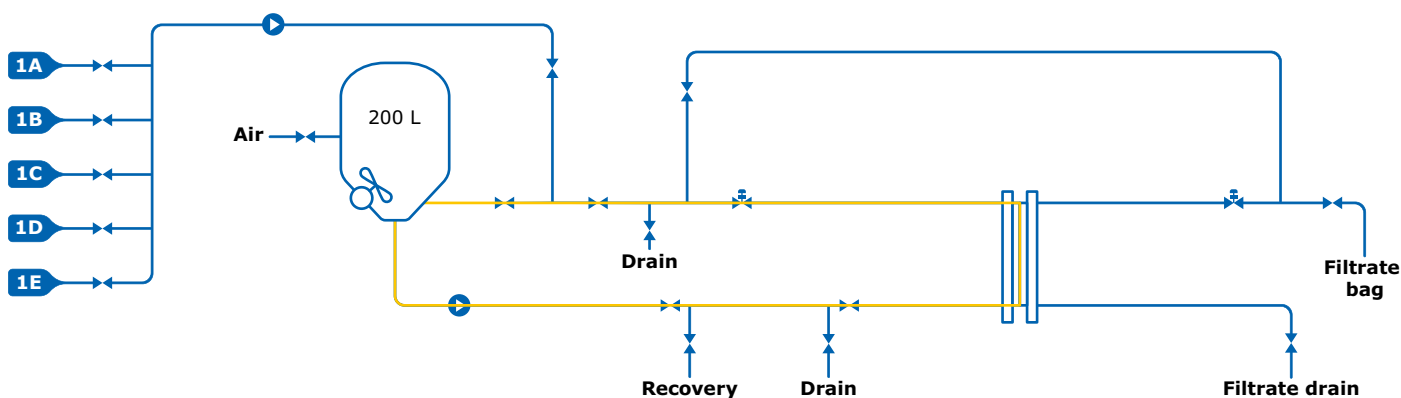

Figure 1. Flow path corresponding to the hold-up volume in yellow.

3 Minimum working volume against feed flow rate

Background and Objectives

Understanding the minimum working volume (MWV) within a system is critical to ensure that air is not entrained into the outlet of the recycle bag at the end of a process. The system hold-up volume is important for recovery, whereas the MWV, which varies with cross flow rate (= feed flow rate), is important to define lowest volume of feed which can be processed. Testing performed within range of flow rates will elucidate how low a solution can be concentrated volumetrically at a given flowrate. Since MWV is dependent on flow rate and viscosity, conditions from 8 to 80 L/min and viscosities of 1 cP and 20 cP were evaluated for the Mobius® TFF 80 system with a 200 L vessel and similar conditions with viscosities of 1 cP with a 500 L vessel.

Materials and Methods

All Flexware® assemblies are installed into the system following the User Guide instructions. Two Pellicon® SIP plates are installed on the holder instead of flat sheet devices. All system components are set to auto mode and the mixer is disabled. The “Membrane Recycle” flow path is opened and the retentate control valve (PCV101) is set to be 100% open. At this stage, two different methods can be used to determine the MWV: an additive method and a subtractive method. The subtractive method has been chosen to perform the tests.

Subtractive method

The recycle bag is inflated and filled up to 30/35 L with either water (1 cP solution) or a 70% glycerin/water solution (20 cP solution). To know the exact amount of solution in the system, the filling step is performed by pumping the solution from a container on a weight scale. Using two SIP plates which block the filtrate line at each side of the holder, the feed pump is slowly ramped up to the maximal flowrate (80 L/min) to remove any air from the recirculation flow path. To ensure that no air bubbles are remaining in the upright tubing between XV704 and XV201; XV201 and XV202 are opened and closed alternatively. Regarding the upright tubing between XV101, XV102 and XV401, trials have shown that running 80 L/min through that section is enough to remove any bubbles, meaning that no further action is required for this part. Once the lines are filled and no air is remaining, the solution is slowly removed from the flow path using the retentate sample port and poured into a container on a tared weight scale allowing for exact volume determination. The solution is removed until the minimum working volume is reached at 80 L/min. This volume is determined by the volume at which the first bubbles enter the feed flow. The volume of water removed is used to calculate the MWV. By subtracting this volume and the two SIP plates volume from the initial amount poured in the system, we obtain the MWV corresponding to this flow. The feed pump flowrate is then decreased in 5 L/min increments between 80 L/min and 20 L/min and 2 L/min between 20 L/min and 8 L/min (minimum flow rate of the system).

At each increment, the minimum working volume is assessed in the same manner. The entire sequence is repeated once to ensure tests repeatability. Trial at a viscosity of 20 cP were only conducted once.

Results and conclusion

The SIP plates were used in this study in place of actual TFF cassettes so that the full range of achievable flow rates could be evaluated without membrane pressure drop limitation and its possible impact on measurement. Trials have shown that the retentate line connection between the recycle bag and the clamshell is crucial to attain lowest minimum working volumes. An incorrect connection, meaning a connection that causes tension on the line (e.g., tubing twist, bag not sitting at the bottom of the tank), translates into a wrong position of the retentate diverter plate inside the recycle bag. This results in an uncontrolled fluid perturbation inside the tank causing air intake at higher volumes. Therefore, it is recommended to verify the correct placement of the retentate port when targeting low minimum working volumes.

Flexware® assemblies are common between the 200 L and the 500 L systems but minor differences of tubing length exist between the two inlet manifold configurations. However, the minimum working volumes were found similar for both configurations, confirming no significant impact.

Bag bottom view from top

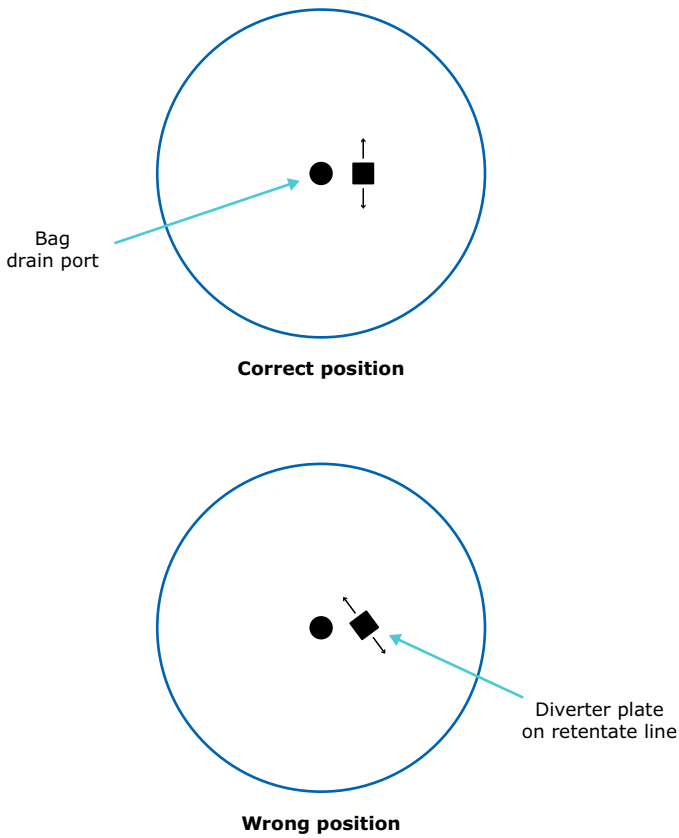

Figure 2.
Bag bottom.

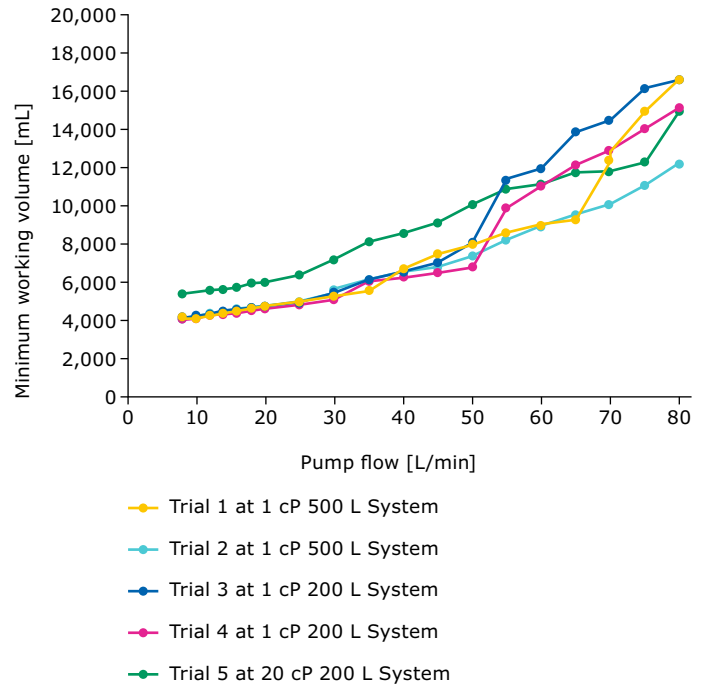

Figure 3.
Minimum working volume versus Flow rate and Viscosity for Mobius® TFF 80 system.

4 System drainability and unrecoverable volume

Background and Objectives

Drainability is a key factor for TFF processes that involve a number of flushing and draining steps. Dead volumes must be prevented as much as possible to reduce the amount of solution needed to flush and to ensure optimal yield during the recovery phase. Therefore, the objective of this test is to measure the total dead volume of the system and provide an idea on its drainability. Trials were conducted on a system with 3 inlets on the feed line and 3 inlets on the transfer line as it represents the worst-case scenario from a dead leg perspective.

Materials and Methods

The entire Flexware® assembly is installed following the instructions provided in the user guide. The mixer motor is engaged with the impeller cup at the bottom of the bag. Two SIP plates are installed on the Pellicon® cassettes holder. The load cells are tared prior to adding 1 cP solution (water) to fill the bag up to 20 L. The exact amount of water used to fill the bag is determined thanks to a weight scale set under the water tank from which it is pumped. The system is set in recirculation mode (retentate and filtrate line diverted to recirculation tank) and the feed pump is started and ramped up to at 80 L/min to remove any air from the flow path. Once no air remains, the feed pump is stopped, and the solution is removed from the flow path using the feed line drain, down to 2 L in the tank. Using the sample port from the retentate line, the volume is brought to the hold-up volume which corresponds to a known amount.

First, the system is drained by opening XV702 and running the feed pump at 10% (helps to drain the feed line correctly). The drained solution is weighted to determine the difference between the filled water and the recovered water which represents the hold-up volume without exterior action. Secondly, the same steps are followed but tubing where water is retained are manually leaned (retentate sample port line leaned toward the clamshell, retentate cassette exit leaned toward the cassette and feed line cassette entry leaned toward the clamshell).

Results

The results for each of the two draining methods are given in the table below. When draining the system, results have shown that the remaining volume in the system is lower when lines are manually leaned to prevent any unwanted retention area. In these conditions, undrainable volume contained in the system is below 320 mL. Further recovery methods can be applied to increase product yield (i.e., buffer rinse, air blowdown, etc.).

Initial volume	Hold-up volume (mL)	3,850	
	SIP plate volume (mL)	1,925 (x2)	
Total (mL)		7,700	
Drained volume		Drained without external action	Drained with tubing lean
	Recovered volume (mL)	7,271	7,402
	Remaining volume in the SIP plates (mL)	20	
Total (mL)		7,291	7,422
Resulting dead volume (mL)		409	278

Table 2.

Dead volumes according to the draining performed for the system configuration with 3 inlets on feed line and 3 inlets on transfer line.

5 System pressure drop versus flow rate and viscosity

Background and Objectives

Selecting an appropriate flow path line diameter for a TFF system involves ensuring that it is not so large as to result in excessive hold-up volume, which limits the extent of protein concentration that can be achieved, while also making sure that it is not so small that it results in excessive pressure drop and linear fluid velocities, which could be detrimental to the product processes. There are two pressure drops that are of concern for this test.

The total system pressure drop is the line drop from the feed pump discharge through the feed lines, membrane holder, and retentate line back to the recycle vessel, which can be measured using the feed pressure sensor (PT001) since the recycle vessel pressure is zero.

The retentate pressure drop is the line drop from the outlet of the membrane holder through the retentate line back to the recycle vessel, which can be measured using the retentate pressure sensor (PT101).

Since the Mobius® TFF 80 system has a maximum pressure rating of 4 barg (58 psig), a high total system pressure drop could limit the flow rate that can be driven through the membrane channels to increase mass transfer and drive high flux. This is especially true at high protein viscosities and high concentrations. A high retentate line pressure drop could limit the minimum transmembrane pressure (TMP) that can be achieved even with the retentate control valve fully open. In a worst-case, this could cause the TMP setpoint for a particular process to be unachievable. The objective of this test is to determine the pressure drop in the feed/retentate flow path as a function of feed flow rate. Since pressure drop is dependent on flow rate and viscosity, as well as line size, conditions from 8 to 80 L/min and viscosities of 1 cP and 42 cP were evaluated.

Materials and Methods

All Flexware® assemblies are installed into the system following the instructions provided in the User Guide. A Pellicon® SIP plate is installed on either side of the Center Manifold Segment (CMS) liner assembly instead of a membrane cassette. The recycle bag is filled with approximately 20 L of water using the transfer pump and inlet manifold. All equipment is set to AUTO mode. And the “Membrane Recycle” flow path is opened. The retentate control valve (PCV101) is set to 0% closed. The filtrate control valve (PCV101) is set to 0% open.

The feed pump (P001) is set to a speed set point of 50% for priming. Once the system is primed, the feed pump is set to feed flow mode with a set point at 8 L/min. Once the flow and pressures stabilize, the feed flow rate (FI001), feed pressure (PT001), and retentate pressure (PT101) are recorded from the HMI display. The feed pump flow setpoint is sequentially increased in small steps and the stabilization and recordings are repeated at each new flow setpoint. After the pressure drop at flow rates from 8–80 L/min are recorded, water is drained from the system using the drain line. The entire sequence is repeated using an approximately 80% w/w glycerin/water solution to generate data at 42 cP. All tests are conducted at ambient temperature (19–24 °C) and viscosity is verified using a Rheo Sense microVISC™ viscometer.

Results

Figure 4 shows the system pressure drop and retentate pressure drop across the full range of achievable flow rates for viscosities up to 42 cP.

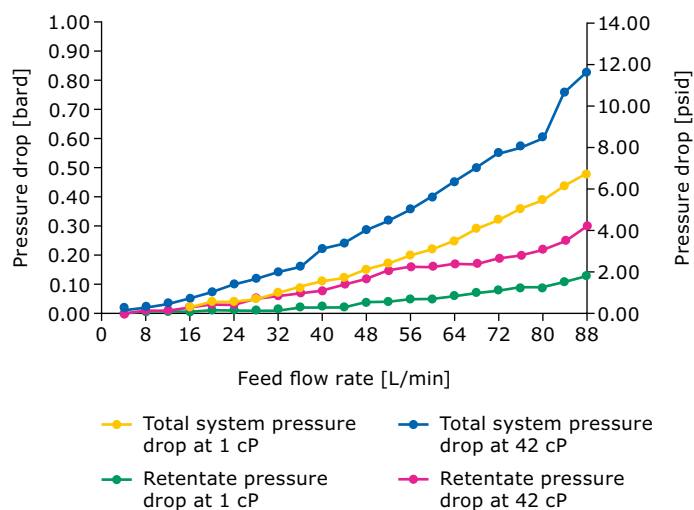

Figure 4. Total and retentate pressure drop (bar and psi) versus feed flow rate and viscosity for Mobius® TFF 80 system.

6 Lowest volume immersing the mixer

Mixing types according to mixer speed and recycle vessel volume at 1 cP

Background and Objectives

Mixing in a TFF system is important to keep the product homogeneous throughout the process. Too vigorous mixing may be detrimental to shear sensitive solutes. It is therefore useful to characterize the vessel mixing across the mixer speed and working volume range to understand surface turbulence, as an indicator of mixing vigor. It is also important to define the minimum volume in the tank allowing to keep the mixer on.

Materials and Methods

The entire Flexware® assembly is installed following the instructions provided in the user guide. The mixer motor is engaged with the impeller cup at the bottom of the bag. The load cells are tared prior to adding 1 cP solution (water) via the transfer pump and inlet manifold to fill the bag entirely. Mixing is started at 5% and after having reached a steady state (around 1 to 2 min) the mixing type is visually determined. Mixing

speed is adjusted by increments of 5% up to 100% using the HMI. Liquid surface is observed. The mixing type is determined at each mixing speed increment, up to the maximum tested (100%). Tank volume is lowered, and the mixing speed excursion is repeated, starting again at 5% mixing speed.

To determine the volume immersing the mixer, the tank is slowly drained using the retentate sample port until the mixer's blade is touching the liquid surface. Resulting tank volume is then considered as minimum volume immersing the mixer.

Table 3 shows the different mixing types considered.

Note: Mixing type is subject to variation based on individual operator appreciation.

Type of mixing	Description/Observation
Calm surface	No surface motion
Gentle mixing	Movement at the surface, no vortex
Mixing	Vortex starting to form but unstable or rapid movement/dimples at the surface
Mixing with turbulences	Stable vortex or very strong mix without bubbles
Turbulences and bubbles	Full vortex and churning, bubble formation

Table 3.
Mixing type definition.

Results and Conclusions

Figure 5 and Figure 6 show the onset surface turbulence at 1 cP and potential areas of concern for shear sensitive operations in the 200 L and 500 L vessels, respectively. The impeller becomes submerged around a volume of 10 L in the 200 L vessel and 26 L in the 500 L vessel. As the volume increases above this level, the mixer speed at which turbulences sets in also increases. At 170 L and 200 L in the 200 L and 500 L vessels, respectively, the full mixer speed no longer generates troubling surface turbulences.

To minimize the subjectivity of this test, more than one operator agreed on the mixing type description and all measurement were performed by the same operator to

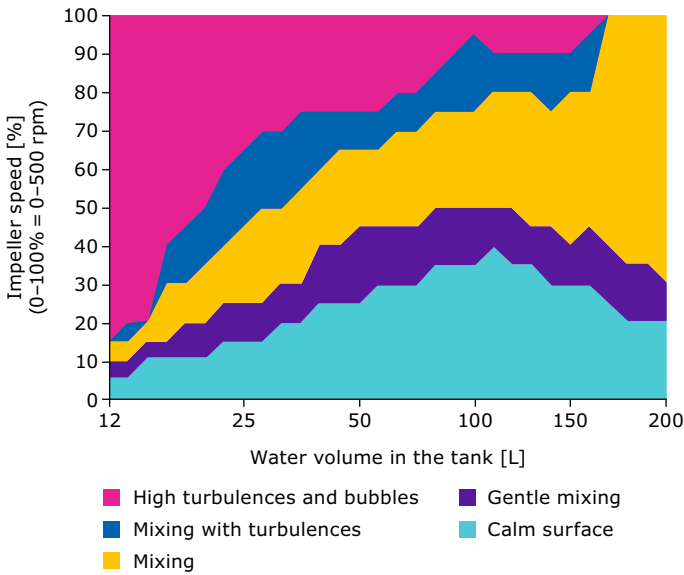

Figure 5. Mixer speed (%) vs. water volume (L) in the 200 L recycle vessel and resulting mixing type.

keep the same appreciation throughout both vessel measurements. Lowest mixable volumes are summarized in table 4.

Note: Mixing types are given for information and may vary depending on the viscosity of the product and the speed of the feed pump (not considered in these measurements).

Tank Size (L)	200	500
Minimum volume required to immerse the impeller (L)	9.1	25.6

Table 4. Minimum tank volume required to fully immerse the impeller according to tank size.

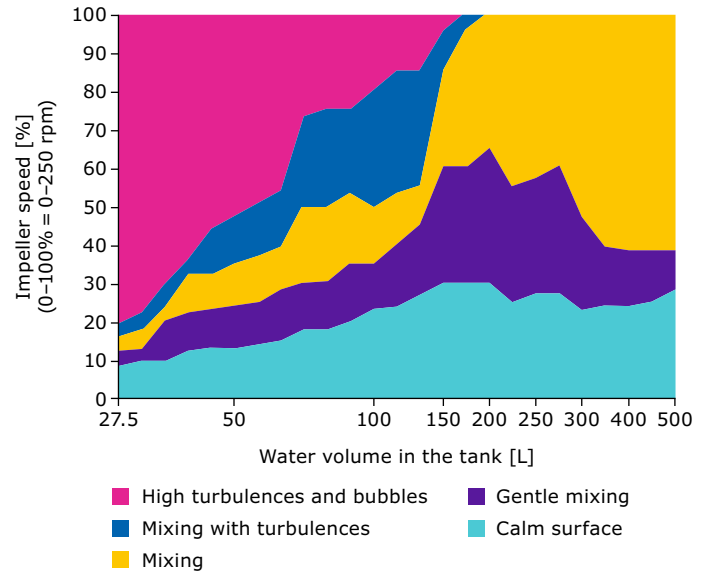

Figure 6. Mixer speed (%) vs. water volume (L) in the 500 L recycle vessel and resulting mixing type.

7 Temperature control performance of jacketed recycle vessel

Background and Objectives

All Mobius® TFF 80 system recycle vessels are jacketed, allowing temperature control during process operations.

For both tank sizes, the double jacket covers the side wall and part of the bottom of the vessel; the removable top part of the 500 L tank is not double jacketed.

Connections include jacket inlet, outlet, and a vent. Active temperature control must be provided by an off-skid temperature control unit (TCU), provided by the end-user. Ability to achieve and maintain target temperature, heating or cooling fluid contained in feed tank, and duration of the heating and cooling illustrate basic performance of the jacketed mixers.

Note: End-user performance will vary depending on the capacity of the TCU used and other parameters. Trials results are provided for information only.

Materials and Methods

The TCU is connected to the jacketed vessel, filled with heat transfer fluid (30% glycol) and the TCU/jacket system is vented. The mixer bag is installed, the mixer is engaged, and the feed/retentate lines are connected. The mixer bag is inflated using the inbuilt inflation system to ensure correct seating of bag. The mixer bag is filled with respective amount of water to simulate product volume. Two volumes are tested for each vessel, approximately ½ and full volume. Lines are then clamped to prevent any recirculation. For each volume, two heating steps (from 20 °C to 45 °C and from 4 °C to 20 °C) and one cooling step (from 45 °C to 4 °C) are performed. All three steps are performed in the same test run for each volume.

Vessel size (L)	Volume tested (L)
200	100
	200
500	250
	500

Table 5.
Volume tested for each tank size.

The Mobius® TFF 80 system software is capable of controlling an external TCU with two modes: bath temperature and product temperature. Therefore, heating and cooling trials are conducted using a single recipe. This recipe is written to stabilize the vessel temperature at 20 °C by applying a bath temperature of 21 °C. The vessel mixer is turned on. Once the vessel temperature is stable at 20 °C during 10 min, the bath temperature setpoint is switched to 50 °C to start the

heating phase from 20 °C to 45 °C. Once the vessel reached a temperature of 45 °C for over 2 min, the bath temperature setpoint is switched again to 0 °C to bring the vessel temperature at 4 °C. Once the vessel reached a temperature of 4 °C for over 2 min, the bath temperature setpoint is switched back to 50 °C to reach a vessel temperature of 20 °C. Once reached the bath temperature control is stopped. During the entire recipe, the mixing speed is set to provide non-turbulent mixing as determined in previous section.

Step	Heat/Cool	Initial temp. (°C)	Final temp. (°C)	TCU bath setpoint (°C)
1	Heat	20	45	50
2	Cool	45	4	0
3	Heat	4	20	50

Table 6.
Summary of the different heating and cooling steps performed for each volume tested.

General information	
TCU used	Lauda VC 10,000
Ambient temperature (°C)	20 to 23 °C
Vessel mixer speed (in rpm)	340 (200 L vessel) or 125 (500 L vessel)
Vessel mixer speed (in %)	68% (200 L vessel) or 50% (500 L vessel)
Product used	DI water

Table 7.
General information on the test performed.

In addition to the inbuilt temperature recorder, thermocouples were used to monitor temperatures in different places inside the vessel. The time to achieve the target end point is recorded.

Temperature sensor number	Position
1	On the interior surface of the bag above the impeller
2	On the interior surface of the bag at the opposite side of the impeller
3	In the middle of the vessel
4	In the middle of the vessel at the liquid surface
5	Between the double jacket and the bag (not in the solution)

Table 8.
Temperature sensors number and placement description.

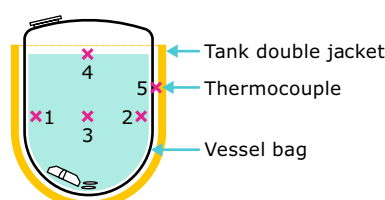

Figure 7.
Transversal view of the system vessel with corresponding thermocouples number and placement.

Results and Conclusions

The results for each of the 2 vessels are given in the tables below. The temperature trends are shown in the figures.

Vessel size	Volume (L)	Test	Initial temp. (°C)	Final temp. (°C)	Time needed (h:mm)
200 L	100 L	1	20	45	2:35
		2	45	4	4:18
		3	4	20	0:49

Table 9. Temperature control performance test results for the 200 L vessel filled at 50%.

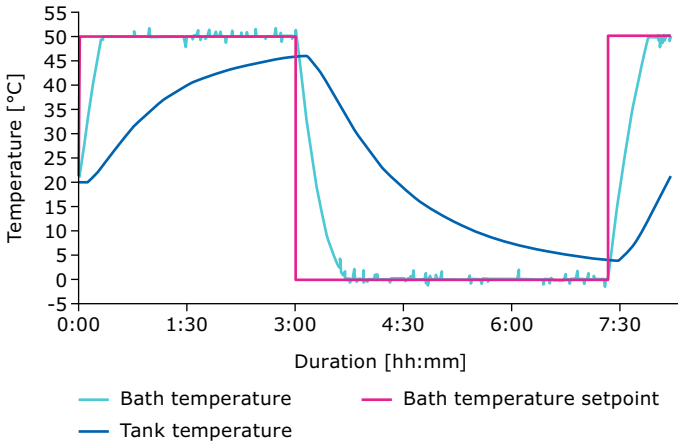

Figure 8. 200 L jacketed vessel, filled at 50%, heating and cooling test.

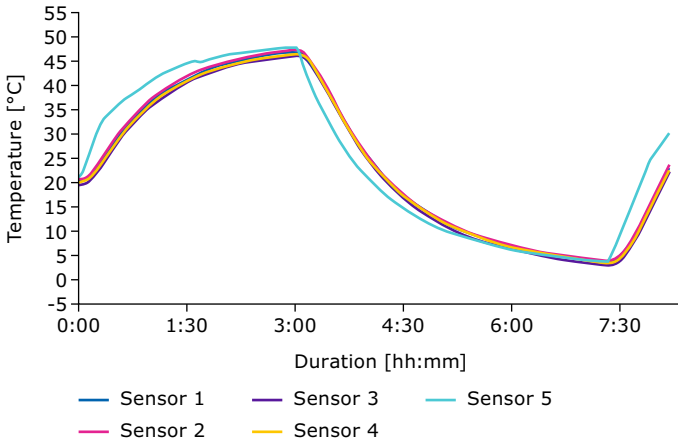

Figure 9. Sensors measurements in the 200 L jacketed vessel, filled at 50%, during heating and cooling test.

Note: End-user performance will vary depending on the capacity of the TCU used and other parameters. These results are provided for information only.

Vessel size	Volume (L)	Test	Initial temp. (°C)	Final temp. (°C)	Time needed (h:mm)
200 L	200 L	1	20	45	2:55
		2	45	4	4:51
		3	4	20	0:57

Table 10. Temperature control performance test results for the 200 L vessel filled at 100%.

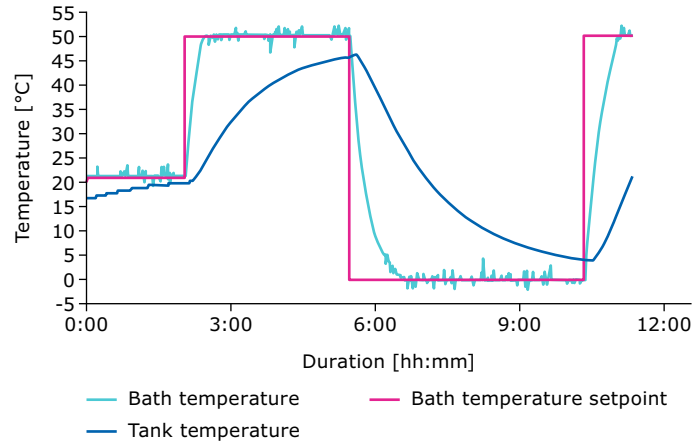

Figure 10. 200 L jacketed vessel, filled at 100%, heating and cooling test.

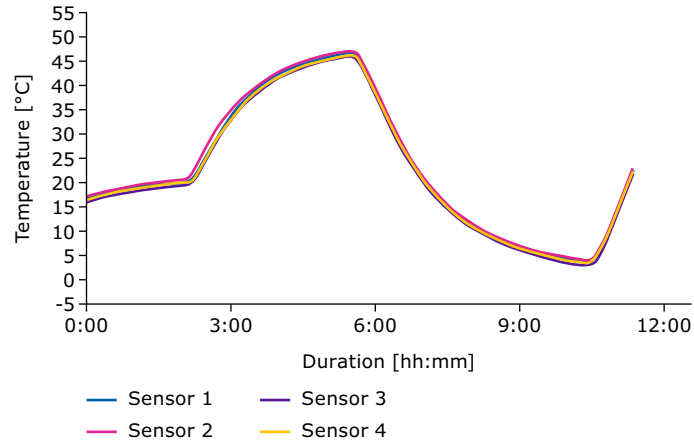

Figure 11. Sensors measurements in the 200 L jacketed vessel, filled at 100%, during heating and cooling test.

Vessel size	Volume (L)	Test	Initial temp. (°C)	Final temp. (°C)	Time needed (h:mm)
500 L	250 L	1	20	45	3:56
		2	45	4	5:46
		3	4	20	1:09

Table 11.
Temperature control performance test results for the 500 L vessel filled at 50%.

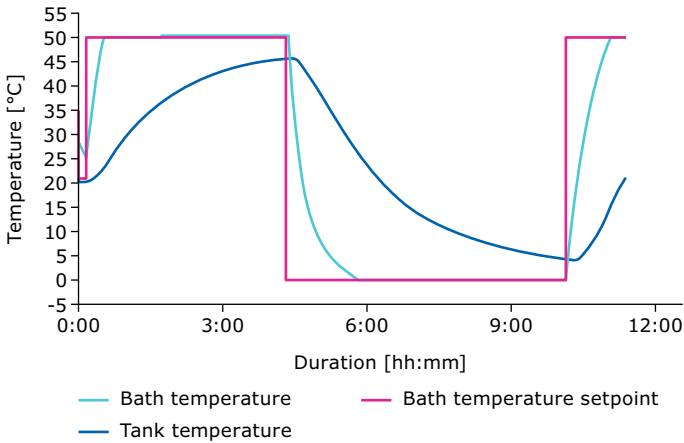

Figure 12.
500 L jacketed vessel, filled at 50%, heating and cooling test.

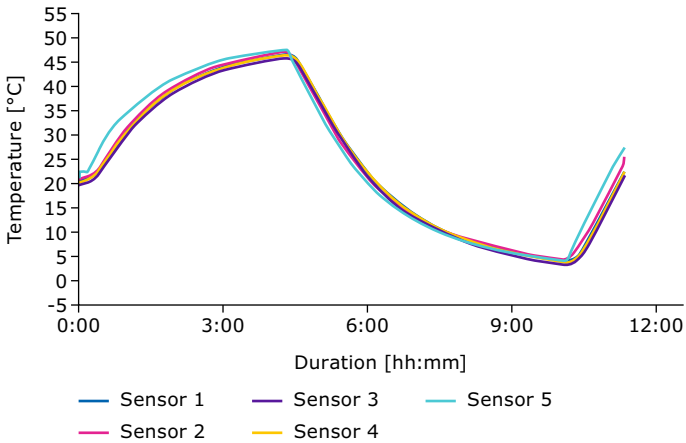

Figure 13.
Sensors measurements in the 500 L jacketed vessel, filled at 50%, during heating and cooling test.

Vessel size	Volume (L)	Test	Initial temp. (°C)	Final temp. (°C)	Time needed (h:mm)
500 L	500 L	1	20	45	5:21
		2	45	4	8:18
		3	4	20	1:35

Table 12.
Temperature control performance test results for the 500 L vessel filled at 100%.

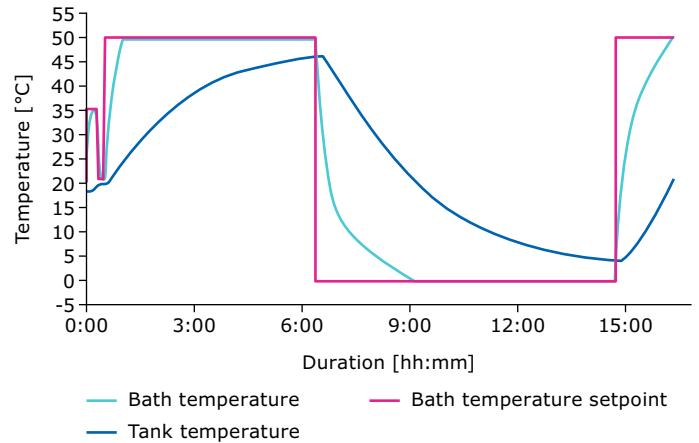

Figure 14.
500 L jacketed vessel, filled at 100%, heating and cooling test.

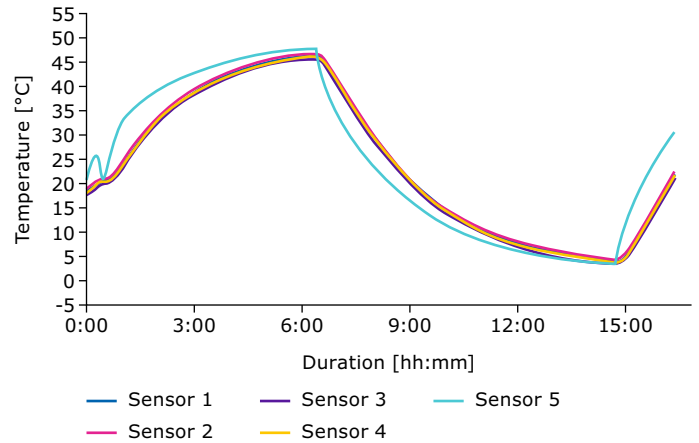

Figure 15.
Sensors measurements in the 500 L jacketed vessel, filled at 100%, during heating and cooling test.

8 Protein UF/DF and recovery step

Background and Objectives

Ultrafiltration is used to purify and concentrate a retained solute. Diafiltration is used to exchange the solvent/buffer. UF/DF steps are used throughout the biomanufacturing process, particularly for final formulation. Achieving a high product yield is a primary metric for UF/DF, along with product purity and a correct buffer formulation. Therefore, a complete UF/DF process with model protein has been run on the Mobius® TFF 80 system to demonstrate automation control features – ability to execute each process step, accuracy of step-to-step transitions based on programmed transition criteria, and ability of all control loops to achieve and maintain their process setpoints during ramp up, intentional hold/resume activation, and/or step changes to the setpoints during processing – and proves high recovery. Feed flow control and retentate pressure control loops were used for the UF/DF. The run is performed on a Mobius® TFF 80 system with a manifold configuration with 3 inlets on the feed pump and 3 inlets on the transfer pump.

Materials and Methods

All Flexware® assemblies are installed into the system following the User Guide instructions. The Mobius® TFF 80 system recycle vessels used in this study is the 500 L tank. Four Pellicon® 3 cassettes (1.14 m² Cat# P3B010A10) are installed on the cassette holder, 2 on each side of the system CMS liner. The cassettes are flushed with water according to the Pellicon® 3 Cassettes Installation & User Guide (AN1065EN00) and using the following system procedures.

Membrane flush in WFI: The retentate drain and upper filtrate drain lines are connected to the sewers using appropriate tubing. Water is connected to the Mobius® TFF 80 system XV006 feed manifold valve. Using the HMI controls, the 2B “Water Source” and “Single-pass Flush (from inlet manifold)” flow paths are engaged, valve XV201 is opened and valve XV202 is closed. The retentate control valve (PCV101) and filtrate control valve (PCV201) are fully opened. Flow control mode is engaged on the feed pump and set to 27 L/min. Retentate pressure control is engaged on the PCV101 and set to 1.5 barg (25 psig), to target

a conversion ratio of 30–50%. Once stable, the pump control is switched to a speed control (keeps the speed corresponding to the previous flow control) and the retentate PCV is fixed in position control (keeps the position corresponding to the previous TMP control). The filtrate drain valve (XV703) is pulsed several times to rinse the line. After around 100 L of water are flushed through the membrane to drain, offline conductivity measurements confirmed both retentate and filtrate outlets achieved a conductivity below 5 µS/cm. Removing the feed line from the source of water allowed the lines to be pumped empty before switching off the pump.

Sanitization: Sanitization is done using a 0.5 M NaOH solution prepared in a Mobius® MIX 200 L and connected to the feed pump inlet XV005. The retentate line drain (XV704) is connected to the same Mobius® MIX 200 L to create a recirculation loop. Using the HMI controls, the “Caustic Source Open” flow path is engaged. Flow 2A control mode is engaged on the feed pump and set to 27 L/min. Retentate pressure control is engaged on the PCV101 and set to 1.5 barg (25 psig), to target a conversion ratio of 30–50%. Once equilibrium is reached, the pump is switched to speed control and the retentate PCV to percentage. The filtrate drain valve (XV703) is pulsed several times to rinse the line with the caustic solution and ensure caustic presence in this part of the membrane during the entire sanitization. Recirculation is run for 1 h. Then, the PCV101 is completely opened, and the feed pump is shut down prior to draining the system using the feed line drain (XV702). Post sanitization flushing is made following the same procedure as for the cassette preservation solution removal described previously (membrane flush in WFI). After the flush, using HMI controls the “System Drain (without recycle bag)” flow path is engaged. The system is kept as is for several minutes to allow gravity drain.

Membrane integrity test: Integrity test is performed using the Integritest® 5 instrument connected to post pump transfer line dedicated connection.

Equilibration and NWP: Equilibration buffer (0.1 M Sodium Bicarbonate) is connected to the transfer manifold valve XV403. Using the HMI controls, the “Recycle Bag Fill” and “Buffer Source Open – Transfer Line” flow paths are engaged and the tank is filled up to 20 L. The retentate and permeate PCV valves are fully opened. The Membrane Total Recirculation flow path is engaged so that both retentate and permeate lines are diverted back to the tank. The feed pump is started at 20% speed control until lines are full. Then the pump control mode is switched to flow control at 27 L/min. Retentate PCV valve is partially closed to reach a TMP of 1.5 bar. Recirculation in these conditions is performed for 10 min before recording the NWP value on the HMI.

Product fill and UF/DF: 298 g Bovine serum albumin (BSA) is diluted to 0.75 g/L with 0.1 M Sodium Bicarbonate to a volume of 400 L in a Mobius® MIX 500 mixer which is connected to the XV402 inlet. An additional 140 L of PBS is prepared as diafiltration buffer in a Mobius® MIX 200 mixer which is connected to the XV403 inlet. The 1A “Feed Source Open” and the “Recycle Bag Fill” flow paths are engaged to transfer 400 L of protein feedstock into the recycle bag using the transfer pump at a speed setpoint of 25%. The mixer is enabled in AUTO mode to adapt the mixing speed to the tank volume. Using a pre-programmed recipe, the following processes are executed: a concentration based on volume from 400 L to 20 L total volume setpoint and a 5-diavolume diafiltration. The feed pump flow control is set at 25 L/min, and the retentate pressure control is set at 1.8 bar. The “Batch UF or Membrane Recycle” flow path is engaged for the concentration step. For the diafiltration step the flow paths “Fed Batch UF or Diafiltration” and “1B Buffer Source Open” are engaged. Level control during diafiltration is set at 15.56 L in the tank, which corresponds to the wanted 20 L without hold-up volume and cassette volume. After the diafiltration step is complete, a recommended depolarization step is performed by engaging the “Batch UF or Membrane Recycle” flow path, fully closing the filtrate control valve, opening the retentate control valve, and setting a feed pump flow of 18 L (corresponding to a delta P of around 0.3 barg, 5 psid pressure drop across the cassette) to recirculate for 10 min, with active mixing.

Product recovery: Product recovery is performed by engaging “Product Recovery 1&3 – Empty recycle bag” flow path and starting the feed pump at 5% speed (internal air blow down). Then the “Batch UF or Membrane Recycle” flow path is engaged and valve XV701 opened to continue recovery of all lines via gravity. An additional buffer recirculation is used to recover any remaining protein from the system and complete the protein mass balance (load versus recovery). Using the HMI controls, the “Recycle bag fill” and “1B Buffer Source Open” flow paths are engaged. The transfer pump is started at 10% speed

to add 14 L of buffer into the system. Then the “Batch UF or membrane Recycle” flow path is engaged and the feed pump is started at 10 L/min to recirculate buffer for several minutes. Recovery is performed following the same step described above. Yields are calculated for both recovery steps (before and after buffer recirculation) using a spectrophotometer.

Note: When designing the entire TFF step, the concentration factor to achieve before recovery generally takes into account the dilution occurring from the final system buffer rinse. Therefore it is common to over-concentrate product at the end of the run, to achieve target concentration after buffer rinse collected in the concentrated product bag. Cleaning starts using 0.1 N NaOH connected to XV005 inlet and standard procedures. Post cleaning NWP measurement is conducted using a dedicated solution reading on the HMI.

Results and conclusion

All the steps of a protein UF/DF process are executed in this trial, from system setup and membrane flushing through to product recovery, including a 20x VCF and 5x DF. Automation features such as flow paths, feed flows and pressure control loops, and recipe control including step transition criteria are employed. The mass balance of the process is the primary metric for this UF/DF trial and is shown in Figure 16. The bulk recovery from the vessel combined with the use of the feed pump internal air blow down for the tubing and cassette yielded 97.3% of the initial protein quantity. Another 3.1% came from the buffer recirculation. The total mass balance recovered represented 100.4%.

Note: Over-achievement of the recovery yield is due to uncertainty on the volume and concentrations measurements combined with rounding errors.

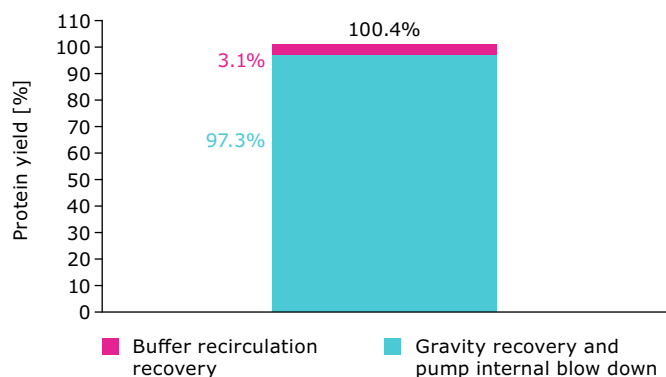

Figure 16.

Yield of protein UF/DF process on Mobius® TFF 80 system depending on the recovery method.

9 Feed Bag sampling and pH measurement volume limit

Background and Objectives

The Mobius® TFF 80 system Flexware® bags are equipped with a sampling point and a pH sensor port. These features may be ideal for solution concentration and diafiltration monitoring via pH or to collect a sample without any flow. Due to the tank geometry, the ports are usable down to a certain volume. The objective of this chapter is to determine this lower volume limit at which both ports are usable.

Materials and Methods

The Flexware® bag is installed in the tank following the User Guide instructions. Retentate and feed lines are clamped as close as possible to the bag, which is then inflated using the inbuilt inflation system. The tank is tared and filled from the top with 50 L DI water (1 cP solution). The bag sample port is opened allowing water to flow out in a bucket until no more water could flow through the sampler meaning that the minimal volume is reached. The weight of the tank is recorded.

For pH measurement, the pH probe is already installed in the Flexware® bag, and by using the retentate sample port, the tank is slowly drained until the pH probe is not able to read a pH value anymore.

Note: Neither impeller nor feed pump is running during measurements, induced turbulences/waves could potentially higher or lower the volume.

Results and conclusion

Both available Flexware® bags are tested (200 L and 500 L). Results given in the table below correspond to the volume at which the sampler and the pH sensor port are not usable anymore. When referring to these number for process applications, it is important to:

- Add at least the amount of solution to be sampled (and an eventual safety margin) to the given volume to ensure that sampling is doable.
- Remember that the measured volumes only represent the amount of solution needed in the tank (rest of the flow path not considered).
- Stay above given values when pH measurement is needed.

It is possible to use the sampling port at lower volumes, but this involves to manually stress the sampler by pulling on the bag (not recommended).

Tank Size (L)	200	500
Sampler volume limit (L)	32	70
pH sensor volume limit (L)		

Table 13.

Summarized volume limits regarding sampler and pH sensor port according to the tank size.

For additional information, please visit SigmaAldrich.com/product-services

To place an order or receive technical assistance, please visit SigmaAldrich.com/contactAF

We have built a unique collection of life science brands with unrivalled experience in supporting your scientific advancements.

Millipore® Sigma-Aldrich® Supelco® Milli-Q® SAFC® BioReliance®

Merck KGaA
Frankfurter Strasse 250
64293 Darmstadt, Germany

